

ALPHA LITE USER MANUAL BOOK



DL SERIES

DLT50

Precautions

[WARNING]

1

Do not open or disassemble the cover to reduce the risk of electric shock.

2

Please wear safety equipment such as safety helmet during work.

3

Please install the signs below for people to bypass when install the product on high truss.

4

The work should be done under the direction of approved specialist who is trained in safety and mechanical installations.

5

The brightness and color temperature before and after aging may be different.

Contents

Safety Information	1
--------------------------	---

Fixture Information

Fixture Information	3
Fixture Exterior View	4
Dimensions	5
Technical Specifications	6

Connection and Setting

Connection Diagram	7
Power Connection	8
Lighting On/Off	9
Address Setting	10



Product name.

DLT50

- ⇒ Average CRI 97 or higher
 - ⇒ COB LED Chip
 - ⇒ Horizontal 360°, vertical 53° angle adjustable
 - ⇒ All-in-one Main drive controller
 - ⇒ Maintain the last signal when DMX signal is lost
 - ⇒ Dimming curve selectable (Linear & curve dimming)
-

Fixture Exterior View



Dimensions

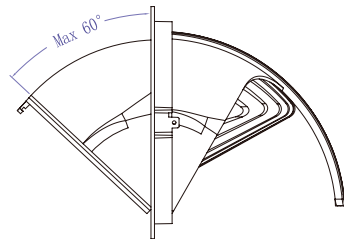
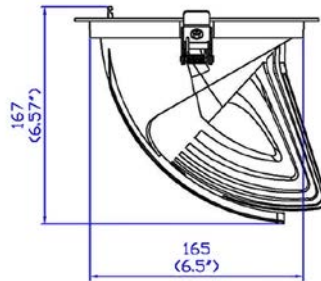
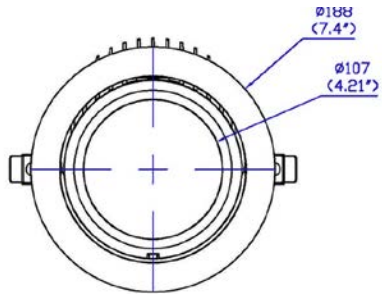

Technical Specifications

LED Chip Type	50W
Estimated LED Lifetime (hours)	50,000
White Light (K)	3200 / 5600 (FCT)
Color Rendition (%)	CRI 97 / TLCI 97
Dimming (%)	0-100 (16-bit)
Cut-off Size Diameter (mm/inch)	175-183 / 6.9-7.2
Beam Angle (°)	15 / 24 / 40 / 60
Tilt (°)	0-53
Signal Control	3-Pin DMX In and Through
Individual Control	Dip Switch
Supported Protocol	DMX512
(Optional) Supported Protocol	DMX512 Wireless
Remote Device Management	Not Supported
Channel Function	Dimming
Power Input Voltage	AC 200-240V
Power Consumption (W)	52
Ambient Temperature Operation (°)	-20~45
Body Dimension (mm/inch) (WHD)	ø190 x 130
Body Weight (kg/lbs)	1.4 / 3.1
Protection Class	IP20

* This specification data is based on the aging state of the equipment, and the brightness and color temperature before and after aging may be different .

Connection Diagram

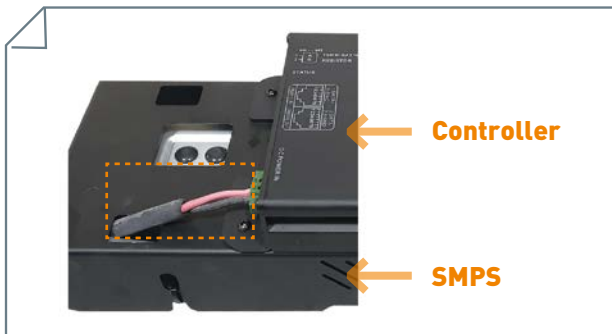
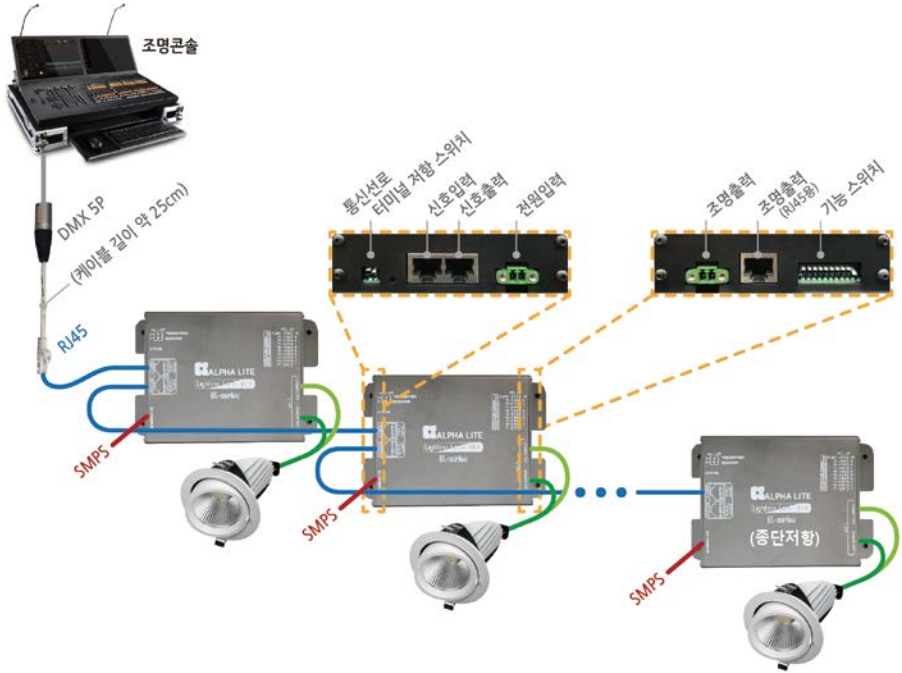

Power Connection

SMPS - AC connection

Connect 100~220V Free Volt AC input cord to connector.

Brown	Yellow - Green	Blue
L	FG	N

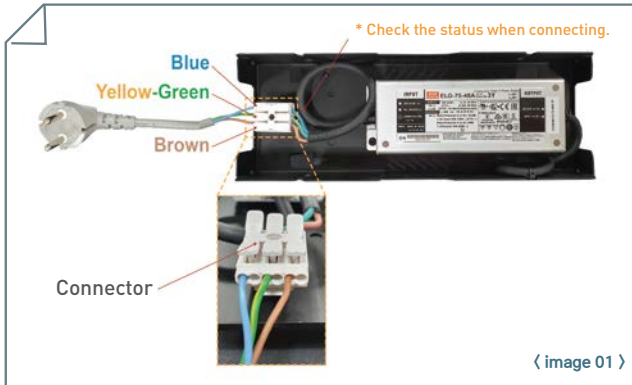

SMPS – AC Thru connection

Other controller SMPS can be connected to SMPS connector with AC power cord.
The line of other SMPS match the color and connect to the right hole of the connector.



Lighting On/Off

Manual operation without DMX signal.

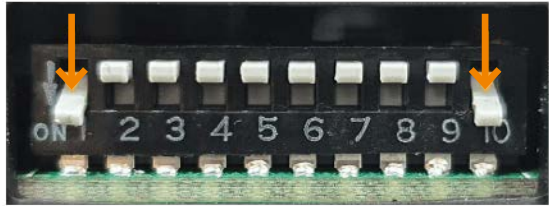

Light on

Dip switch #1 and #10 go down, The light turn on.

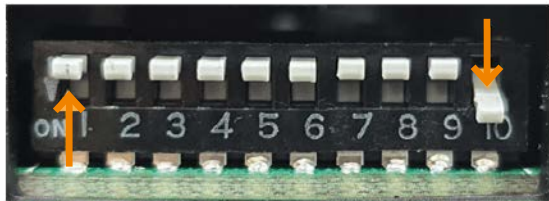

Light off

Dip switch #1 goes up while the light is on, the light turns off.



- WARNING** 1. **In case of malfunction due to DMX communication noise** : Solve communication problems by selecting and turning on/off the dip switch #1 or #2 of the terminating resistor
2. **Caution** : For terminating resistor setting, only the last controller on the line is operated.
(Other controller dip switches remain off)

Address Setting

Free Recommended Application

Dip switch value (binary) can be easily converted.

This APP is only for explaining the settings and you don't have to use this APP.



DMX Calc (Android)
Dezelectric



DMX Dip (iOS)
Matthias Bauch

Initial Setting

Adjust the APP layout to match the controller's function switch layout.

- When the address is 000, the dip switch must be all up.
- Number 1~9 must be listed in order from the left.

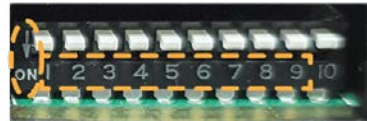

[Initial setting value]

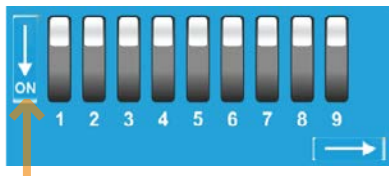

1~9 numbers left and right position change.

When the address is 000, the dip switch up and down position change.

Address Setting

Touch the up and down arrows to set the desired address number. Then, it will be converted to dip switch value on the screen below.



Dip switch value (binary method) through APP is applied to the function switch of the controller.



* Address : 000

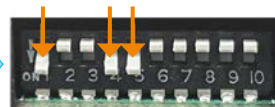

* Address : 025



ALPHA LITE USER MANUAL BOOK

—

<Tel> 82-2-6317-0464

<Fax> 82-2-2039-0464

<E-mail> hello@alpha-lite.net

<Web> www.alpha-lite.net